

StatSpin[®] Express

PRIMARY TUBE CENTRIFUGE

2



2 Minute Spin

...Plasma for
Coag Testing

...Plasma for
Cardiac Markers

...Serum or Plasma
for Stat Chemistry

THE EXPRESS 2 WILL CUT TURNAROUND

StatSpin[®] Express
PRIMARY TUBE CENTRIFUGE

2

Rapid Blood Separation

The StatSpin[®] Express 2 can improve turnaround time and productivity in any lab! By placing it next to any analyzer that requires serum or plasma, you'll see an immediate improvement in test efficiency and turnaround time. Samples are processed as they arrive; no need for batching, no unproductive time spent waiting for the centrifuge...you'll have results in minutes. For peak workflow, several units can actually provide higher throughput than a larger, more costly centrifuge.

StatSpin[®] Express 2 is ideal for:

- Rapid plasma for coagulation tests
- Sample prep for stat chemistry
- Cardiac profiles for the ER
- Sharp separations for send-out
- Anywhere rapid serum or plasma is needed



ND TIME IN HALF

Cut turnaround time in half!*

Improve productivity. One study found that a typical hospital laboratory could reduce cardiac profile TAT from about one hour to thirty minutes by switching to plasma separator tubes, streamlining sample transport and installing a StatSpin Express in the workstation.

* Evaluation of the StatSpin® Express primary tube centrifuge for preparation of samples for measurement of cardiac markers on the ACS:180® System. Bayer Corp., Diagnostic Division, Walpole, MA. AACC 99, Abstract #77.

High quality results for coag or chemistry

The Express 2 can produce serum or plasma equal to tubes spun for 7-10 minutes in conventional clinical centrifuges. Gel barrier tubes are separated rapidly with minimal barrier distortion. Processed tubes can be used on automatic sampling equipment without contaminating the sample probe.

The Chart shows data on the ability of the Express to produce quality plasma from PST tubes for testing chemistry analytes. A full report of this chemistry testing as well as a detailed independent report on platelet count is available upon request.

- **Fast** Rapid acceleration and dynamic braking reduce waiting for routine blood separations. Spins in 2 or 3 minutes.
- **Accurate** Microprocessor control maintains speed and time to within 5%.
- **Compact** Takes less than 7 inches (18cm) of bench space, fits almost any work area or instrument cart.
- **Quiet** Generates only about 60dB of noise won't disturb nearby workers.
- **Safe** Cover interlock system, chamber gasket and proven mechanical containment for operator safety. UL Listed (U.S./Canada), CE marked.
- **Simple** Load tubes and press start preprogrammed cycles simplify run time selection.
- **Easy to Maintain** 10% bleach-compatible surfaces and polypropylene rotor make cleaning easy. Disposable chamber liners available for added efficiency.
- **Self-diagnostics** error code lights help reduce chance of operator error and aid in instrument trouble-shooting.

Chemistry Plasma

Marker	StatSpin Express 2 8500 rpm 2 MINUTES		Beckman Centrifuge 3000 rpm 10 MINUTES	
	Mean	Range	Mean	Range
Potassium	4.04	3.3 - 4.7	4.05	3.3 - 4.7
AST	21.8	12 - 52	21.7	12 - 52
ALT	16.0	3 - 38	16.0	3 - 38
LDH	134	68 - 205	137	77 - 209

24 Duplicate Samples in PST Tubes (Plasma Separator) Analyzed in a Beckman CX-7

StatSpin[®] Express

2

StatSpin Express 2 includes a remote universal power supply that works off any single phase electrical power from 100-240V. The power supply has an IEC 320 receptacle so virtually any standard "computer-type" power cord can be used.



Specifications:

Speed/Force	<ul style="list-style-type: none"> • 8500 rpm/4440 xg (± 250)
Cycle Time	<ul style="list-style-type: none"> • Quick Spin 30 seconds • Normal 120 seconds • Hard Spin 180 seconds
Acceleration Time	<ul style="list-style-type: none"> • 20 seconds to 95% of speed
Deceleration Time	<ul style="list-style-type: none"> • < 30 seconds
Tube Accommodation	<ul style="list-style-type: none"> • Accepts up to 5 mL blood tubes (13 x 75 mm), Monovette syringe tubes and smaller tube formats (see ordering information)
Power Requirements	<ul style="list-style-type: none"> • 100 to 240V, 50/60 Hz, 1.7 amp <p>(Remote power supply has a 50 cm/3.5 ft. line to the centrifuge and a 5 ft. North American power cord. Replacement AC power cord must have an IEC 320 connector and meet <HAR> standard.)</p>
Dimensions (H x W x D)	<ul style="list-style-type: none"> • 15.2 x 16.8 x 21.9 cm. (6.0 in. x 6.6 in. x 8.6 in.)
Weight	<ul style="list-style-type: none"> • 2.3 kg (5 lbs)
	<p>Specification subject to change without prior notice. The StatSpin Express drive and suspension system are covered under U.S. Patent No. 5,566,919. StatSpin is a registered trademark of StatSpin, Inc. Monovette is a trademark of Sarstedt, Inc.</p>

Ordering Information

SSX2	StatSpin Express 2 for 100-240V, 50/60 Hz. Includes 4-place rotor (RTX4), universal power supply, removable chamber liner, four 5 mL Inserts and North American power cord.
SV01	Inserts for 5 mL Tubes (13 x 75 mm) 4/pk. Included with centrifuge.
SV02	Inserts for 3 mL Tubes (10.25 x 64 mm) 4/pk.
SV03	Inserts for 2 mL Tubes (10.25 x 47 mm or BD Microtainers) 4/pk.
SV04	Inserts for 1.5 - 2 mL Microtubes (e.g. LipoClear) 4/pk.
DL01	Disposable Chamber Liners 10/pk.
RTX4	Replacement Express 2 Rotor Includes four SV01 Inserts.



The 24V line to the centrifuge includes a locking nut for secure installation.



60 Glacier Drive
Westwood, MA 02090
Tel: 781.551.0100
Fax: 781.551.0036
800-782-8774
www.proiris.com

Express 2 Primary Tube Centrifuge

Operator's Manual

StatSpin[®]

Operator's Manual
Express 2 Primary Tube Centrifuge

Model Number M501-22

FOR *IN VITRO* DIAGNOSTIC USE

Product Number

SSX2 - Express 2 for 100-240 VAC, 50/60 Hz

StatSpin is a registered trademark of StatSpin Inc., a Subsidiary of IRIS International, Inc.

Copyright 2001, 2003

Printed in U.S.A.

Table of Contents

How to use this manual	ii
Section 1	1
Unpacking and Installation	1
Inspect Packaging.....	1
Verify Contents.....	1
Install System.....	1
Connect Power.....	1
Section 2	2
System Overview	2
Principle and Intended Use	2
Symbols and Definitions	2
Error Indicators	3
Accessories.....	3
Section 3	4
Operating Instructions	4
Opening and Closing the Cover	4
Removing and Installing the Rotor	4
Spinning the Sample	5
Section 4	6
Maintenance	6
Overview	6
Cleaning	6
Checking the Rotor Speed.....	7
Service	7
Troubleshooting	8
Appendix	9
Appendix A - Specifications	9
References	10
StatSpin Warranty	11

How to use this manual

This manual along with information contained on product labels and in package inserts should provide you with all the information you need to operate and maintain the Express 2.

Notes appear in italics to highlight information. When the information requires special attention, a caution symbol appears next to the italicized text.



Please pay close attention to the instructions that accompany the notes and symbols as well as the standard laboratory practices outlined by your facility and local regulatory agencies. The table below lists all the CAUTIONS/WARNINGS for the Express 2.

	<p>WARNING - North American Installation: <i>Only use the power supply included with the unit. Use of other power supplies or transformers will damage the Express 2 electronics and void the warranty.</i></p>
	<p>WARNING - Outside of North America: <i>Do Not Use the Line Cord Supplied. Use power cord for at least 1.0 Amp or more with an IEC320/CEE22 female connector and male connector suitable for the power outlet to be used.</i></p>
	<p>CAUTION - <i>The cover interlock bypass is designed for emergency use only. If the equipment is not used properly, safety may be impaired.</i></p>
	<p>CAUTION- <i>The rotor (RTX4) has a finite lifespan that is dependant on usage. Cracks or swelling that develop indicate the rotor should be replaced immediately.</i></p>
	<p>CAUTION – <i>Failure to properly install the rotor may result in damage to the centrifuge and will void the warranty.</i></p>
	<p>CAUTION – <i>Never operate the Express 2 without the rotor in place.</i></p>
	<p>CAUTION - <i>Replace balance tube every 10 cycles to prevent possible breakage due to the repeated stress of centrifugation.</i></p>
	<p>CAUTION – <i>Unplug the Express 2 from the wall outlet before performing maintenance.</i></p>
	<p>WARNING – <i>Do not expose Express 2 and its rotor to strong or concentrated acids, bases, esters, aromatic or halogenated hydrocarbons, ketones or strong oxidizing agents.</i></p>
	<p>CAUTION – <i>DO NOT spray the bowl or outer surfaces with detergent or bleach. Excess liquid will harm the electronics and subsequent problems may not be covered under warranty.</i></p>
	<p>CAUTION - <i>Universal Precautions should be followed on all specimens, regardless of whether a specimen is known to contain an infectious agent. (See references)</i></p>

Please use the system as intended. Improper use of the Express 2 Primary Tube Centrifuge and/or its accessories may cause damage to the system, inaccurate results, or potentially nullify warranties.

The Express 2 Primary Tube Centrifuge, and its associated components are covered under US patent nos. 4,846,974 & 4,981,585 & 5,566,919

Unpacking and Installation

Inspect Packaging

The Express 2 and its accessories are delivered in one carton. If the centrifuge or accessories have suffered any damage in transport, please inform your carrier immediately.

NOTE: Save shipping carton and components to simplify return should service be required.

Verify Contents

The package contains:

One Express 2 centrifuge (Model No. M501-22)

One Centrifuge Rotor (Product No. RTX4)

Four Rotor Inserts for 13x75 mm tubes (Product No. SV01)

One Universal Switching Power Supply
(StatSpin Product No. 01-3553-001, APS Product No. AD-740U-1240)

One grounded line cord (for North American use only)

One Operator's Manual

One Tool for Removing Rotor, 7/16" Nut Driver

Install System

1. Place the Express 2 on a level surface suitable for laboratory instrumentation.
2. Maintain a 300mm clearance boundary around the centrifuge for ventilation and safety.
3. Position the Express 2 away from direct sunlight and sources of heat or cold.
(See Appendix A for specifications.)
4. Remove blue foam packaging around the rotor before operating the centrifuge.

Connect Power

Plug the power supply into a grounded outlet supplying the voltage and frequency indicated on the power supply. When power is connected, the 30 s. LED will illuminate and the cover lock will release.



WARNING - North American Installation: Only use the power supply included with the unit. Use of other power supplies or transformers will damage the Express 2 electronics and void the warranty.



WARNING - Outside of North America: Do Not Use the Line Cord Supplied. Use power cord for at least 1.0 Amp or more with an IEC320/CEE22 female connector and male connector suitable for the power outlet to be used.

Section 2

System Overview

Principle and Intended Use



For in vitro diagnostic use for rapid separation of whole blood contained in original collection tubes.









The Express 2 is a microprocessor controlled, high-speed bench top centrifuge designed to rapidly separate blood in the original evacuated or syringe type collection tubes.

The four-place 30° angle rotor included with the centrifuge is designed to provide rapid separation while minimizing potential re-suspension of cells. The speed is fixed at 8500 rpm (± 250 rpm), producing a centrifugal force of 4440 xg at the maximum tube radius of 5.5 cm. The operator may select three factory-set timed cycles, each cycle spinning for 30, 120 and 180 seconds.

Symbols and Definitions

	Start button	The <i>start</i> button initiates a pre-timed cycle at the speed selected. NOTE: <i>The Express 2 does not have an on/off switch and is normally left plugged in and "on".</i>
	Stop/open button	The <i>stop/open</i> button interrupts the cycle and stops the centrifugation. This button may also be used to release the cover.
	Cycle selector	This button allows for selection of the appropriate cycle.
	Error/Service indicator	The red LED identified, as <i>error/service</i> is illuminated continuously or flashing when service is required.
	Power input	DC Power Input: 24V DC Plug-in

Symbols and Definitions (cont.)

	Product/Reference Number	Indicates the StatSpin product/catalog number
	Caution	Statement of caution/warning, read instruction carefully
	Temperature limitation	Indicates storage requirements range
	EC Representative	European Community Authorized Representative
	For <i>in vitro</i> diagnostic use	Clarifies for use as <i>in vitro</i> diagnostic only
	Non sterile	Indicates non-sterile product
	Serial Number	Indicates instrument serial number code
	Consult Instructions	Consult instruction manual or insert sheet for further explanation

Error Indicators

Error codes for the Express 2 are specified by a combination of the *Error/Service* LED flashing or continuous and any combination of the cycle LEDs on the front panel.

Error/Service =  *Quick Spin* = 30 s *Normal Spin* = 120 s *Hard Spin* = 180 s

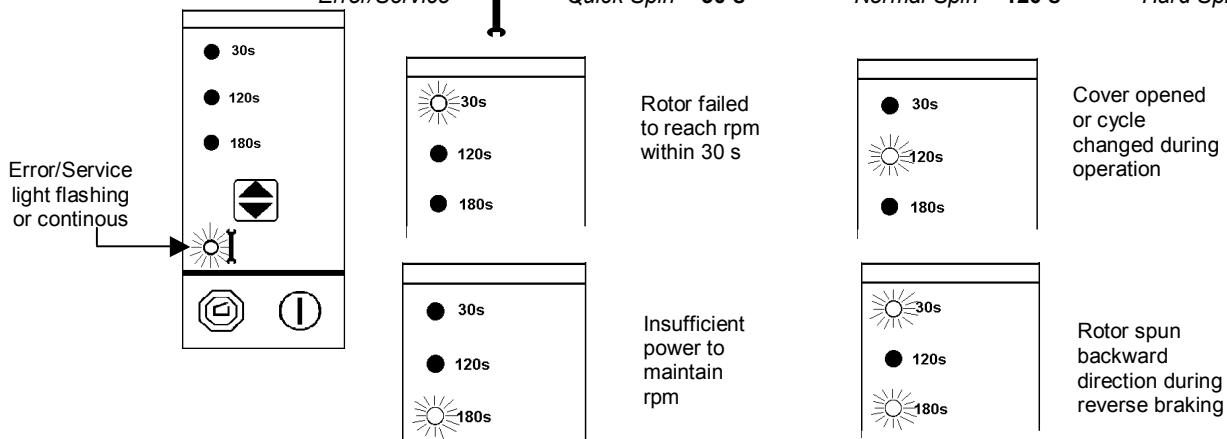

Error/Service light will continuously illuminate when the centrifuge has achieved a total cycle count of 18,000, which is the useful life of the drive system. Drive mechanism needs replacing. Contact an authorized service center.

Accessories

Product No.	Description
SV01	Inserts for 5 mL tubes (13 x 75 mm or 10.25 x 82 mm) 4/pk. Included with centrifuge
SV02	Inserts for 3 mL tubes. (10.25 x 64 mm) 4/pk.
SV03	Inserts for 2 mL tubes. (10.25 x 47 mm or BD Microtainers) 4/pk.
SV04	Inserts for 1.5-2 mL Microtubes (e.g. LipoClear) 4/pk.
DL01	Disposable chamber liners. 10/pk.
RTX4	Express 2 Rotor. Includes four SV01 inserts.

Operating Instructions

Opening and Closing the Cover

The system's electrically operated cover interlock mechanism prevents operation until the cover is completely closed and latched, and prevents the cover from being opened while the rotor is turning. When the cover is completely closed and locked an operating cycle can be initiated.

The system is also equipped with a manually operated latch that holds the cover down after spinning is complete. The interlock is automatically released at the end of the operating cycle or by pushing the *stop/open* button. Squeeze the black latch pieces together to open cover.

Cover Interlock By-pass

The electronically operated cover interlock mechanism can be released manually by inserting the straightened end of a large paper clip or similar object into the small hole in the center of the front membrane panel. Manually push the lock lever inward about one inch (25mm) to release the interlock mechanism if the *stop/open* button does not release the cover.



CAUTION - The cover interlock bypass is designed for emergency use only. If the equipment is not used properly, safety may be compromised.

Removing and Installing the Rotor

The Express 2 is shipped with the rotor installed. To prevent possible damage to the centrifuge's motor mount, it is important to remove the rotor whenever the centrifuge is moved or shipped to another location.



CAUTION- The rotor (RTX4) has a finite lifespan that is dependant on usage. Cracks or swelling are signs of fatigue, replace immediately.

1. Remove the tube inserts from the rotor.
2. Remove rotor, locking nut and washer from the rotor holder using 7/16" nut driver.
3. Gently rock the rotor back and forth until the mounting pins on the rotor holder release.
4. Remove the rotor.

To re-install rotor:

1. Remove the tube inserts from rotor. Place rotor on rotor holder, ensuring the two mounting pins on the rotor holder are aligned with two of the four small holes near the center of the rotor.
2. Gently rock the rotor back and forth to ensure the rotor seats properly on the rotor holder.
3. Install washer, then nut and secure the rotor by tightening the nut with the 7/16" nut driver provided.
4. Re-install the tube inserts into the rotor cavities. The centrifuge is now ready for use.



CAUTION- Failure to properly install the rotor may result in damage to the centrifuge and will void the warranty.

Spinning the Sample

Loading



CAUTION - Never operate the Express 2 without the rotor in place.

1. Ensure the appropriate tube inserts are installed. The Express 2 centrifuge is provided with four tube inserts for 13 x 75 mm tubes (Product No. SV01). Other sizes are available (See accessories).
2. Two or four tubes may be processed at one time. The rotor must be properly balanced to ensure smooth operation.
3. Use the same size and style tubes in opposite positions. Balance liquid in tubes to within 0.5 mL.



CAUTION - Replace balance tube every 10 cycles to prevent possible breakage due to repeated stress of centrifugation.

4. Close and latch the centrifuge cover.
5. Select the appropriate cycle by pressing the cycle selector until the desired LED is illuminated. (See Table 1)
6. Press *start* button.

Table 1: Express 2 Cycle Settings. The operator should experiment with different settings to achieve optimum performance for specific applications. The following are general guidelines:

Setting	Speed	Time
30s Intended to provide a short spin to immediately separate the red cells from the plasma/serum.	8500 rpm	30 seconds
120s Intended to produce good quality plasma/serum from whole blood for chemistry or coagulation.	8500 rpm	120 seconds
180s Intended to provide a minimal particle/cell count and should be used for specialized applications. (e.g Lipoclear®)	8500 rpm	180 seconds
<ul style="list-style-type: none">▪ The normal spin (120 s) can be used for most chemistry and coagulation applications.▪ The hard spin (180 s) can be used for gel separator tubes. (PST/SST)		

NOTE: The Express 2 has no “on-off” switch, and therefore is normally left plugged in and “on”.

Unloading

1. Upon completion of the cycle, the rotor decelerates to a complete stop in 25 seconds and the latch interlock automatically unlocks.
2. Squeeze the black latch pieces together to open cover.
3. Carefully remove tubes using care not to re-suspend the sediment.

Section 4

Maintenance

Overview

StatSpin recommends that instrument operators perform periodic inspections and preventative maintenance on all StatSpin instruments. Contact StatSpin's customer service department or distributor if, at any time, the instrument is not functioning properly.



CAUTION - *Unplug the Express 2 from the wall outlet before performing maintenance.*



WARNING - *Do not expose Express 2 and its rotor to strong or concentrated acids, bases, esters, aromatic or halogenated hydrocarbons, ketones or strong oxidizing agents.*

Cleaning

The Express 2 is supplied with a disposable bowl liner to simplify routine cleaning. Additional bowl liners are available. (Product No. DL01). The liner should be replaced monthly or whenever a spill occurs. Clean the outside surfaces and switch overlay panel with a water-dampened cloth and mild detergent. Clean the inner surface of bowl with a mild detergent, and if necessary, a disinfectant, wiping surfaces with a **dampened** cloth using 70% alcohol or 10% bleach solution.



CAUTION - *DO NOT spray the bowl or outer surfaces with detergent or bleach. Excess liquid will harm the electronics and subsequent problems may not be covered under warranty.*

General Cleaning

1. Open centrifuge cover.
2. Unplug the power supply from the electrical outlet.
3. Remove all tubes and inserts. Remove the rotor (see Removing and Installing the Rotor).
4. Remove the black gasket surrounding the chamber by pulling up one end of the gasket.
5. Remove the bowl liner and dispose. Install a new bowl liner.
6. Replace the black gasket around the chamber opening.
7. Reinstall rotor (see Removing and Installing the Rotor).
8. Plug in the power supply.

Rotor Disinfecting

1. Open centrifuge cover.
2. Unplug the power supply from the electrical outlet.
3. Remove all tubes and inserts. Remove the rotor (see Removing and Installing the Rotor).
4. The rotor and inserts may be soaked in detergent and warm water or a 10% bleach solution.
5. **DO NOT** attempt to clean an insert that has a broken tube. Dispose of insert immediately.
6. Dry the rotor and inserts with a clean absorbent paper towel or allow to air dry.
7. Re-install the rotor (see Removing and Installing the Rotor).

Checking the Rotor Speed

The rated speeds ($\pm 5\%$) can be checked with a photoelectric tachometer available from many sources. If the Express 2 fails to achieve operating speed 8500 rpm $\pm 5\%$ contact your distributor or StatSpin Customer Service department.

Service

There are no user-serviceable parts. Refer all service to qualified service personnel.

Reference the StatSpin Warranty for further instruction. Be sure to complete and return the warranty card as directed.

Decontamination before returning for service

Any instrument or accessory containing accumulated blood and/or other biological or chemical deposits must be cleaned prior to shipment to the manufacturer/dealer for service. This decontamination is required by Federal Law (Title 48 and 49 of the Federal Regulations) and in accordance with the Environmental Protection Agency's Regulations for Biohazard Waste Management. StatSpin personnel cannot perform this decontamination.

Troubleshooting

No Power Light

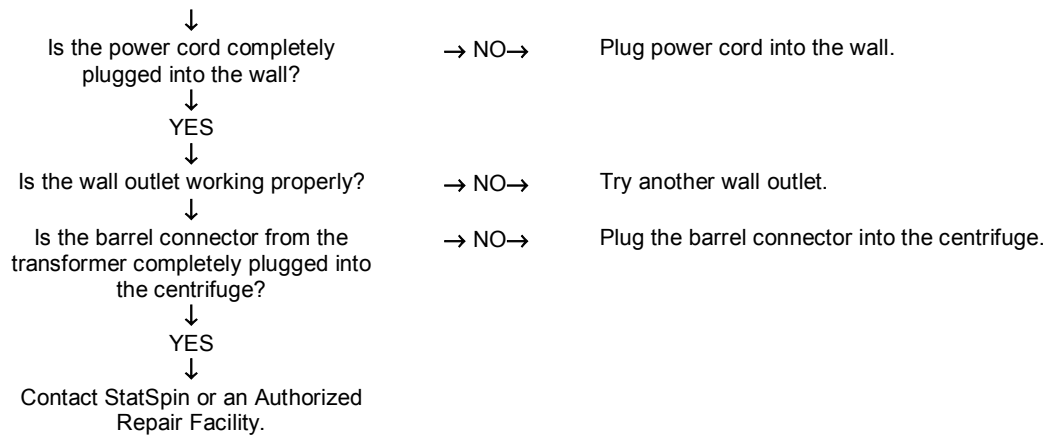

Centrifuge Will Not Spin/Shuts Off Prematurely

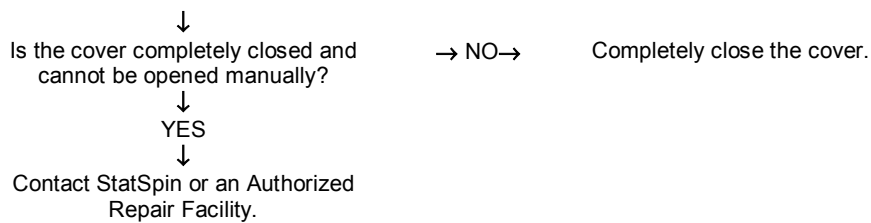

Centrifuge will not open at end of cycle

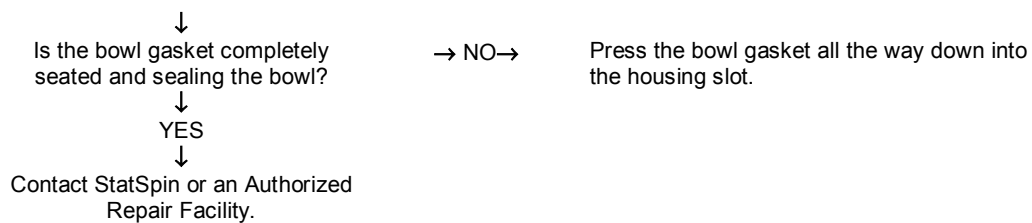

Appendix

Appendix A - Specifications

Product No.	SSX2
Model No.	M501-22
Speeds	8500 rpm \pm 250
Force	4440 xg
Cycles	30s: 30 seconds 120s: 120 seconds 180s: 180 seconds
Acceleration Time	Approximately 20 seconds
Deceleration Time	Approximately 25 seconds
Electrical	24 Volts, DC, 1.7 amp. Includes switching power supply for 100-240 VAC, 50/60 Hz
Dimensions	Diameter 6.6"/ 16.8 cm Height 6.0"/15.2 cm Weight 5 lbs/2.3 kg
Environmental	Indoor use Altitude up to 2000m Temperature 5°C to 40°C Maximum relative humidity 80% for temperatures up to 31°C decreasing linearly to 50% relative humidity at 40°C Main supply voltage fluctuations not to exceed +/- 10% of the nominal voltage Transient over-voltages according to installation category II Pollution degree 2

References

1. NCCLS. "Protection of Laboratory Workers from Occupationally Acquired Infections; Approved Guideline-Second Edition." NCCLS document M29-A2 [ISBN 1-56238-453-8]. NCCLS, 940 West Valley Rd, Suite 1400, Wayne, Pennsylvania 19087-1898 USA, 2001.
2. CDC. Recommendations for prevention of HIV transmission in health care settings. MMWR (Suppl. No. 2S):2S-18S, 1987.
3. CDC. Updated: US Public Health Service Guidelines for the Management of Occupational Exposures to HBV, HCV and HIV and Recommendations for Post Exposure Prophylaxis. Appendix A and B. MMWR 50 (RR-11): 1-42, June 29, 2001.

StatSpin®

A Subsidiary of IRIS International Inc
Norwood, MA 02062 USA
Phone: 800-782-8774
or 781-551-0100
Fax: 781-551-0036
www.statspin.com

EC REP

mdi Europa GmbH
Wittekamp 30
D-30163 Hanover Germany
+49-511-39089530
Made in USA



StatSpin Warranty

StatSpin, Inc., a Subsidiary of IRIS International, Inc. warrants that the instruments shall be free from defects in material and/or workmanship, under normal use and service, for the period expiring twelve (12) months from the date of installation, provided the purchaser has completed and forwarded to StatSpin the Warranty Registration Card. StatSpin will, at its discretion repair or replace any unit covered under this warranty returned to StatSpin with shipping costs prepaid. Repaired or replaced instruments supplied under this warranty carry only the remaining portion of the original warranty and repairs shall not interrupt or prolong this warranty. For warranty terms and conditions outside the United States, contact your Authorized StatSpin Distributor.

No warranty extended by StatSpin shall apply to any instrument that has been damaged due to misuse, negligence, accident, or damage resulting from unauthorized repairs, alterations, or improper installation.

StatSpin makes no warranty other than the one set forth herein. This warranty is given expressly in lieu of all other warranties, expressed or implied. The purchaser agrees that there is no warranty of merchantability or of fitness for any intended purpose and that there are no other remedies or warranties, expressed or implied, which extend beyond the description on the face of the agreement. No agent or employee of StatSpin is authorized to extend any other warranty or assume for StatSpin any liability except as set forth above. This warranty is only applicable to the original purchaser.

Limitation of Liability

StatSpin shall not be liable for any loss of use, revenue or anticipated profits, or for any consequential or incidental damages resulting from the sale or use of the products. The purchaser shall be deemed liable for any and all claims, losses, or damages incurred by the use or misuse of the StatSpin instrument by the purchaser, its employees or others, following receipt of the instrument or other items.

STATSPIN EXPRESS 2 CENTRIFUGE
MODEL M501-22

